

TinyCOMP for the Atari 600XL NTSC

Version 1.4 – June 2022

It's Cute! It's positively microscopic. It's TinyCOMP: a universal RF to Composite output (North America) mod board, that allows you to convert many classic 8-bit systems to CVBS (**NTSC**) output. No more fuzzy signals, or needing some old bulky **TV**. You can even improve the quality of video capture from original hardware! Currently known and tested to work on Atari 600XL, Timex Sinclair 1000, and Atari 2600 console, however This board could be used on other computer that have a RF modulator and no composite output. You would only have to locate the audio and video inputs into the RF modulator as the rest should be the same. This is not covered in this documentation.

The Atari 600XL (US model) comes with an RF (Radio Frequency) modulator port on the back which is connected to the “Cable In” of your TV. If you are like me, and don't really want to do this but instead want to connect to a composite monitor or so converter for HDMI, then this small project is for you.

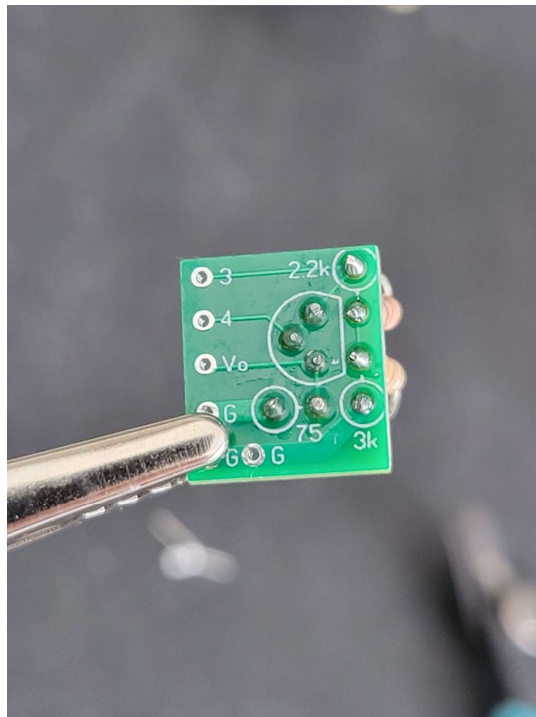

Components

1 – 2.2K resistor

1 – 3K resistor (I used 3.3k resistor)

1 – 75-ohm resistor (I use 2 resistors 56-ohm and 18-ohm in serial to give me 74-ohms which close enough for this project)

1 – 2N2222 transistor with metal can. See schematic section below

1 – RCA female jack

Assorted colored wires for connections. Solid wire works best

Heat shrink tubing of several sizes

Schematics

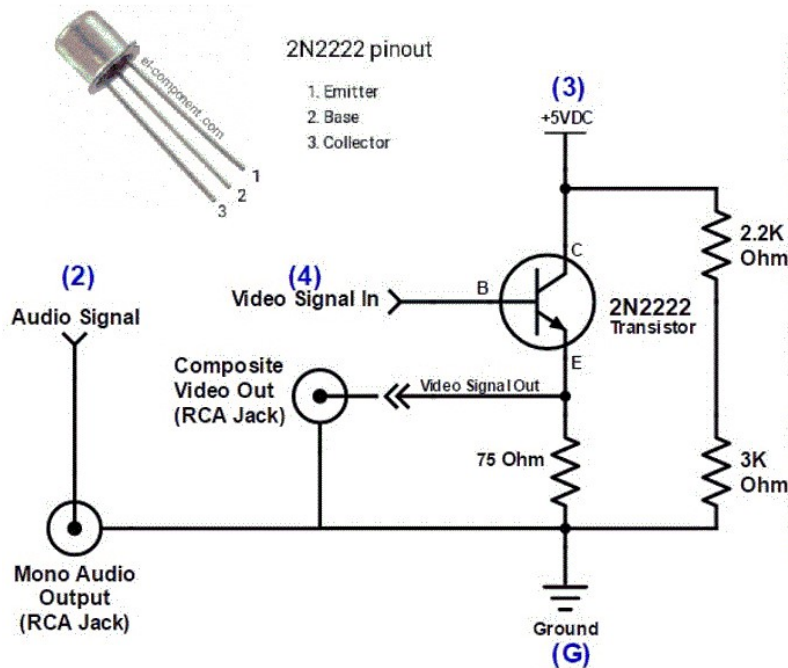

Note:

1. On the 2N2222 there is a small tab on the can of the transistor, this is the emitter connection. This is marked as "1" in the diagram on right side.
2. The schematic diagram is not mine as I found it on the internet. However, this is a simple amplifier circuit and you could use your own
3. The transistor picture was provided by el-component.com
*We do not take any responsibility for accuracy, damages to you, your computer, monitor etc. We have tested to the best of our abilities and will work with you correct issues. This product is sold as is and is up to the buyer to install the correct components and install correctly. Verify with manufacture's schematics before connecting any modification to your computer or other equipment. If you are not sure how to connect, please contact a friend or someone who is technical and works with electronics. **Ensure your computer or console is in proper working order before you make this modification! We do not take any responsibility for damages to your computer or console. You should be technical enough to do soldering and troubleshooting before starting this project***

Building and Connecting the Composite Modifications

1. Collect all the parts needed to construct. Check **Components** section above
2. Install components of the proper side. The side with the component values should be the solder side

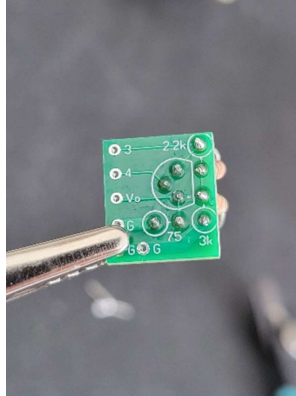

3. Install the resistor for 2.2K and 3K but first bending the leads as in the picture below. If not, there is no room to install them

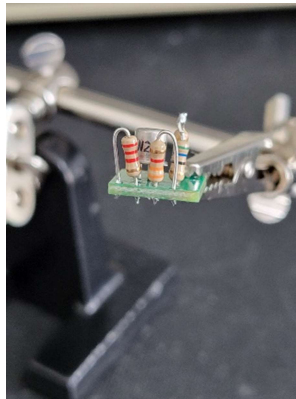

4. Install the 75-ohm resistor. If you are using 2 resistors to make this value, ensure they are soldered end to end (serial connection)

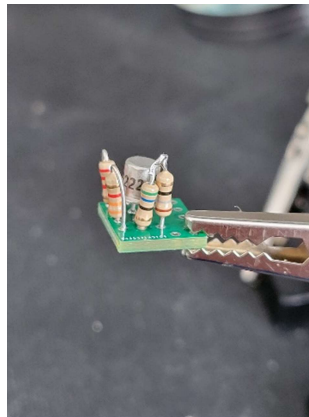

- Next, bend all resistors outwards a bit so that the transistor can be installed. Make sure that the emitter connection is placed in the hole that is marked with a small "E"

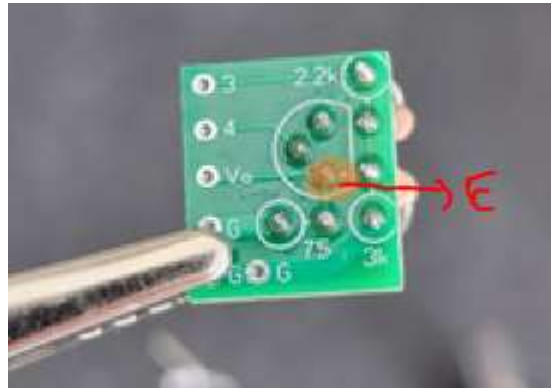

- Once installed. Cut the heat shrink tubing over each component. This will ensure the leads do not touch each other

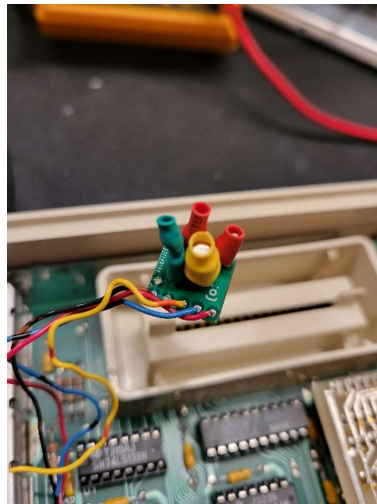

- Install each wire as per below

- Pin labeled "3" goes to +5V DC
- Pin labeled "4" this is the videos input from RF modulator to the board
- Pin labeled "G" connects to ground. There are 3 ground points, however you only need to connect to one of them and not all three
- Pin labeled "Vo" is the composite video output. Connect this to RCA jack that is inside the RF modulator. Don't forget to cut\disconnect the resistor that connect to this RCA jack. Solder it back if you want to use the RF connection

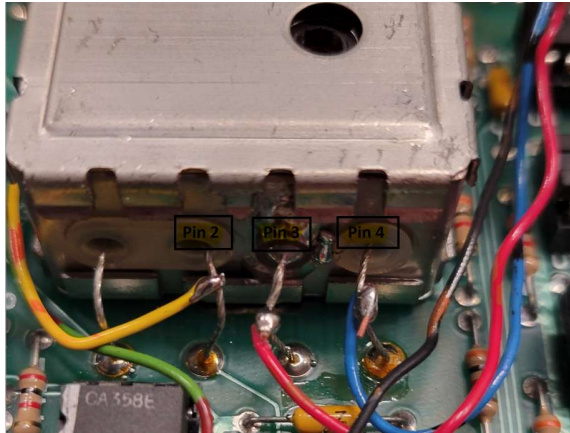

8. Next you will need to connect the ground connection, "G". this can be connected anywhere you have a ground. I use pin 4 of this 555 timer IC.

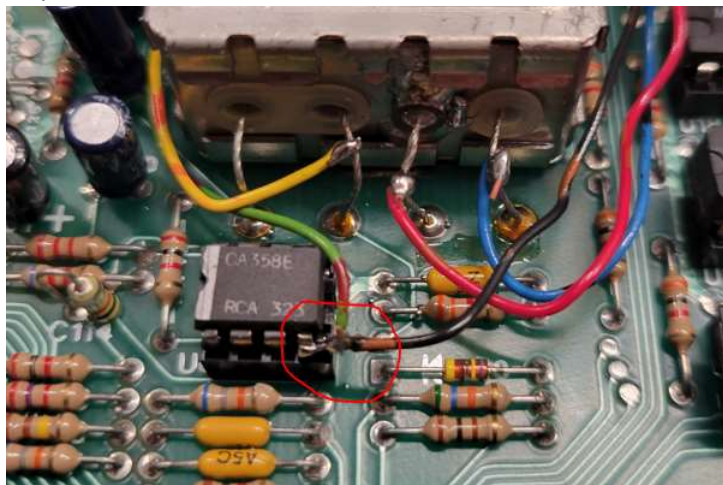

9. You will have to ground connections. First is to the board and the second is for the audio RCA jack. The video ground is already connected via the RF modulator case
10. Your board's wiring should look something like this

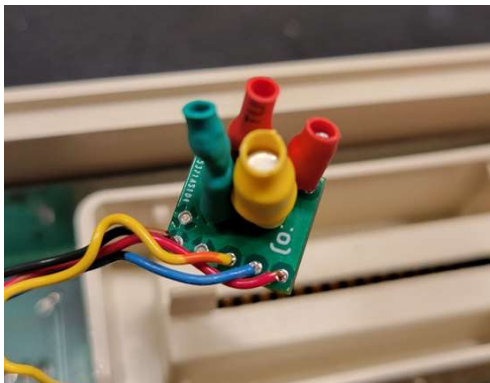

11. Connect the audio jack connections. Here you should drill a hole and install the RCA jack. This part is not covered here as you can find lots of YouTube videos on it. Basically, drill a whole big enough for the RCA jack connector, insert and tighten screw. Connect the ground wire (outside sleeve) as per picture above. Connect the center connection to pin 2 as in step 7

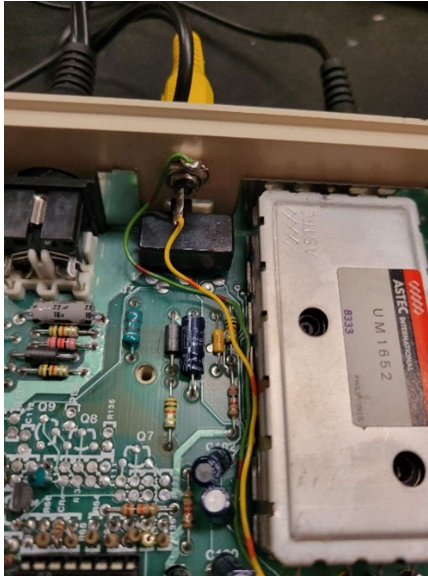

12. In the RF modulator, cut one side of the resistor that is connected to the RCA jack. Do not remove this resistor as you can reconnect it if you ever want to use RF connection. Finally, connect a wire from there to labeled "Vo"



13. Ensure all wires are connected. Double check all soldering points, wire location, etc.
14. Connect RCA cable from RF modulator jack to "Video in" on your composite monitor
15. Connect RCA cable from newly installed RCA jack to "Audio in" on your composite monitor
16. Turn on monitor
17. Turn on your computer, wait a moment then you should see a picture

Troubleshooting

No Video

1. Check computer power supply
2. Ensure all wires are connected to the proper locations. See step 7.
3. Ensure ground connections are correct
4. Ensure +5V DC is available at Pin 3 on the RF Modulator
5. Ensure correct values are used for resistors
6. Ensure transistor is connected properly. "E" marking on the board should be where the emitter connection is made
7. Ensure is working without the modification by reconnect the resistor in the RF modulator and test that you can see a picture on a TV

No Sound

1. Check computer power supply
2. Ensure all wires are connected to the proper locations. See step 7.
3. Ensure ground connections are correct
4. Ensure RCA jack is good. Using a multimeter, check that there is no connection from the RCA jack's outer connection with the middle connector

No Video and Sound

1. Check computer power supply
2. Check to see if LED light on computer is on
3. Disconnect all wires added and reconnect the resistor in the RF modulator and test that you can see a picture on a TV

Computer Not Working Before Starting This Project

1. Contact someone who is familiar with the repair of this computer

Questions\Support

- See website for updated files
- Email: retrointeldiy@gmail.com and use tile: TinyCOMP

*We do not take any responsibility for accuracy, damages to you, your computer, monitor etc. We have tested to the best of our abilities and will work with you correct issues. This product is sold as is and is up to the buyer to install the correct components and install correctly. Verify with manufacture's schematics before connecting any modification to your computer or other equipment. If you are not sure how to connect, please contact a friend or someone who is technical and works with electronics. **Ensure your computer or console is in proper working order before you make this modification! We do not take any responsibility for damages to your computer or console. You should be technical enough to do soldering and troubleshooting before starting this project.***